

# Kvaser Leaf User Guide



Copyright 2011-2023 Kvaser AB, Mölndal, Sweden  
<https://www.kvaser.com>

Printed Wednesday 13<sup>th</sup> September, 2023

We believe that the information contained herein was accurate in all respects at the time of printing. Kvaser AB cannot, however, assume any responsibility for errors or omissions in this text. Also note that the information in this document is subject to change without notice and should not be construed as a commitment by Kvaser AB.

(This page is intentionally left blank.)

## Contents

<b>1</b>	<b>Introduction</b>	<b>5</b>
1.1	Kvaser MagiSync™	5
1.2	Difference between USB standards	7
<b>2</b>	<b>General for all Kvaser Leaf products</b>	<b>8</b>
2.1	Introduction	8
2.2	Identification	8
2.3	Power	10
2.4	LEDs	11
2.5	USB connector	11
2.6	D-SUB connector	12
2.7	OBDII Connector	15
2.8	J1939-13 Connector	15
2.9	Technical data	17
<b>3</b>	<b>Kvaser Leaf Light HS</b>	<b>17</b>
3.1	Introduction	17
3.2	LEDs	18
3.3	Technical data	18
<b>4</b>	<b>Kvaser Leaf Light Rugged</b>	<b>20</b>
4.1	Introduction	20
4.2	LEDs	20
4.3	Technical Data	20
<b>5</b>	<b>Kvaser Leaf SemiPro LS/HS/SWC</b>	<b>22</b>
5.1	Introduction	22
5.2	LEDs	22
5.3	Technical Data	22
<b>6</b>	<b>Kvaser Leaf SemiPro Rugged</b>	<b>24</b>
6.1	Introduction	24
6.2	LEDs	24
6.3	Technical Data	24
<b>7</b>	<b>Kvaser Leaf Professional LS/HS/SWC/LIN</b>	<b>26</b>
7.1	Introduction	26
7.2	LEDs	26
7.3	Technical data	26
<b>8</b>	<b>Kvaser Leaf Professional Rugged</b>	<b>29</b>
8.1	Introduction	29
8.2	LEDs	29
8.3	Technical Data	29

---

<b>9</b>	<b>Frequently Asked Questions</b>	<b>31</b>
<b>10</b>	<b>Support and software updates</b>	<b>32</b>
10.1	Driver installation . . . . .	32
10.2	Firmware Updates . . . . .	32
10.3	Driver Updates . . . . .	32
<b>11</b>	<b>Safety Instructions</b>	<b>33</b>
11.1	Intended Use . . . . .	33
11.2	Usage Warning . . . . .	33
<b>12</b>	<b>Disposal and Recycling Information</b>	<b>34</b>
<b>13</b>	<b>Legal information</b>	<b>34</b>
13.1	Electromagnetic compability . . . . .	34
13.2	EU Regulatory Compliance . . . . .	35
13.3	FCC Regulatory Compliance . . . . .	50
13.4	About this manual . . . . .	65
13.5	Patents, copyrights, and trademarks . . . . .	65
<b>14</b>	<b>Document revision history</b>	<b>66</b>

# 1 Introduction

The Kvaser Leaf family currently consists of three basic products: Kvaser Leaf Light, Kvaser Leaf SemiPro and Kvaser Leaf Professional. Kvaser Leaf SemiPro and Kvaser Leaf Professional use the patented Kvaser MagiSync™ that you can read more about in Section 1.1 Kvaser MagiSync™. All Kvaser Leaf devices use USB to communicate with the computer. Section 1.2, Difference between USB standards, on Page 7 describes the basic differences between the various USB standards.

## 1.1 Kvaser MagiSync™

Kvaser MagiSync™ is a new innovative way of synchronizing several different channels. All units are synchronized, achieving a high precision virtual clock accurate to the microsecond. No external cables are necessary; you get instant synchronization as soon as you connect. For this to work the units must reside on the same USB root hub. If they do not they will not be synchronized, see Figure 1 on Page 6 and Figure 2 on Page 6.

Usually, a computer has a USB controller with one root hub in a computer. If you use that one, you do not need an external USB hub to get your Kvaser Leafs synchronized. The easiest way to verify the setup is to check Synchronized Hardware under Tools in Kvaser Device Guide, then select the new item in the hardware tree called Synchronized Hardware. MagiSync Groups should now be visible to the right. If all your hardware is placed in one Kvaser MagiSync™ Group, then you are ready to go.

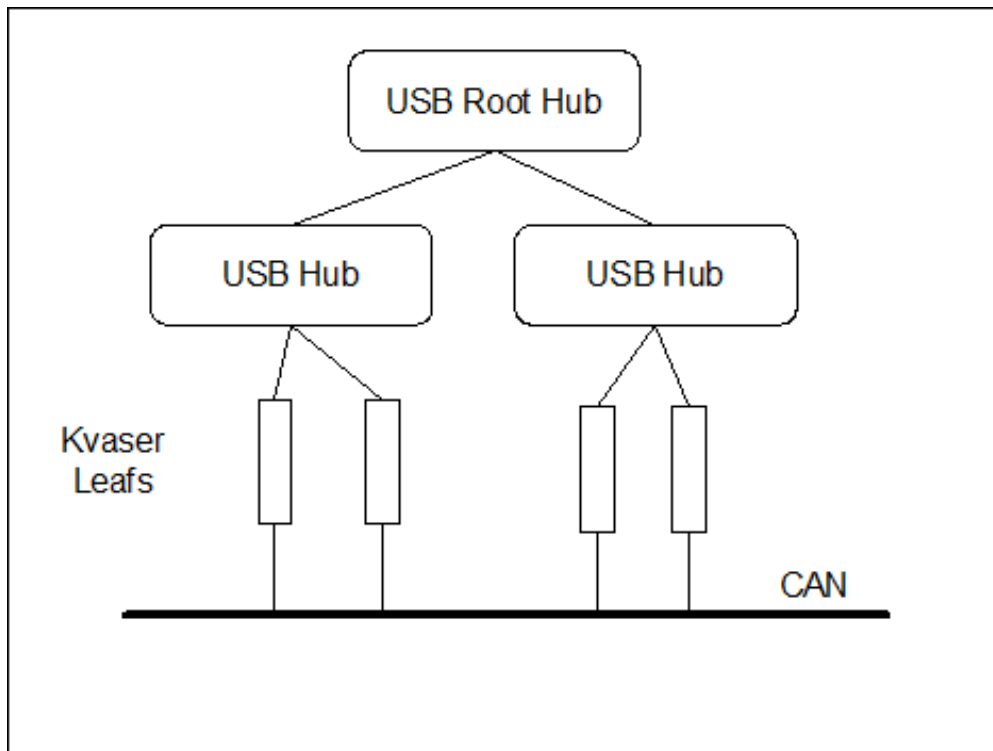

Figure 1: Kvaser Leaf synchronization. All devices are synchronized in this setup.

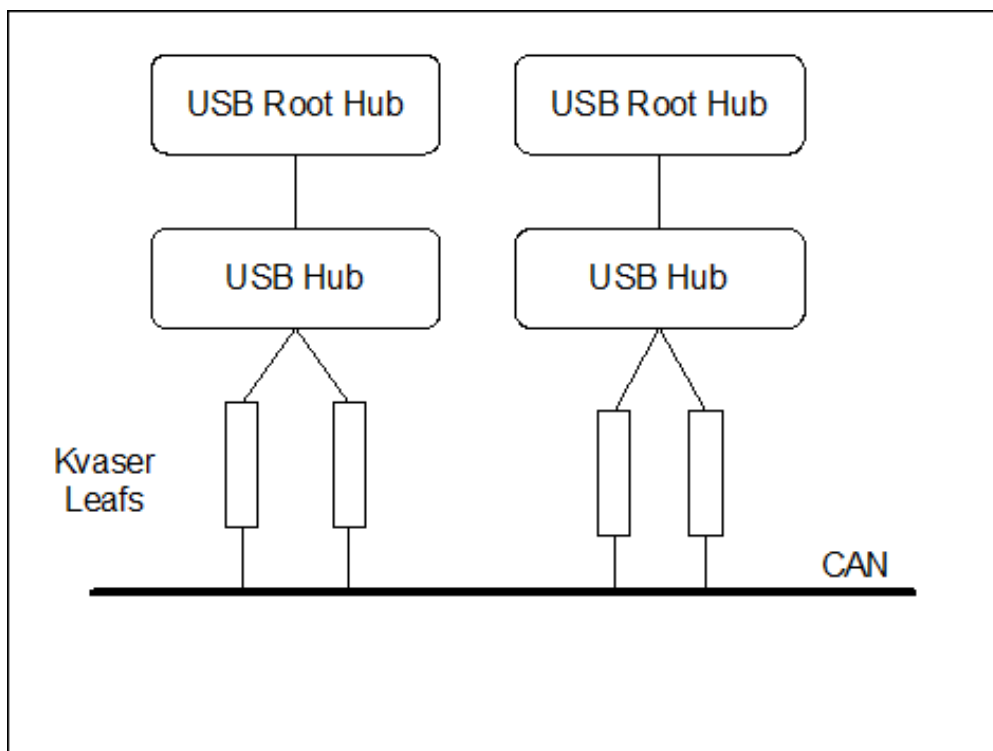

Figure 2: Kvaser Leaf synchronization. The devices are not synchronized in this setup.

## 1.2 Difference between USB standards

There are three different USB standards: USB 1.0, USB 1.1 and USB 2.0. The major difference between USB 1.X and USB 2.0 is the speed. USB 1.X provides **low-speed** at 1.5 Mbit/s and **full-speed** at 12 Mbit/s. On systems with USB 2.0 support, USB provides **full-speed** at 12 Mbit/s and **high-speed** at 480 Mbit/s. USB 2.0 is backwards compatible with 1.X.

Kvaser Leafs will work on your computer with all standards, but if you do not have USB 2.0, the Kvaser Leafs will use full-speed at max. 12 Mbit/s.

## 2 General for all Kvaser Leaf products

### 2.1 Introduction

The Kvaser Leaf family currently consists of three one-channel high-speed versions, two one-channel low-speed versions, two one-channel Single-Wire CAN (SWC) versions and one LIN version; see Table 1.

	High-speed	Low-speed	SWC	LIN
Kvaser Leaf Professional	X	X	X	X
Kvaser Leaf SemiPro	X	X	X	
Kvaser Leaf Light	X			
Kvaser Leaf Professional Rugged	X			
Kvaser Leaf SemiPro Rugged	X			
Kvaser Leaf Light Rugged	X			

Table 1: The Kvaser Leaf family

All Kvaser CAN Leafs use USB 2.0 and handle messages with 11-bit (CAN 2.0A) and 29-bit (CAN 2.0B) identifiers. All Kvaser CAN Leafs can transmit and receive remote frames and also detect error frames.

The Kvaser Leaf family also has the following features:

- Small plastic housing (Kvaser Leaf Light Rugged has an aluminium housing)
- Minimum power consumption (approx. 70 mA)
- 100 % compatible with applications that use Kvaser's CANlib (i.e. applications written for LAPcan, LAPcan II, PClcan, PClcan II, PCcan, USBcan, USBcan II, etc.)

### 2.2 Identification

When a Kvaser Leaf is inserted, its index is written to the registry. The next time a Kvaser Leaf of the same type is plugged into the same port, the index is reused if possible, or else the first available "slot" is used. This means that the device numbering will be the same every time, if you plug the devices into the same ports in the computer. If you use different ports, the numbering might be different.

You can use Kvaser Device Guide to locate the Kvaser Leaf by flashing the LEDs. You will find Kvaser Device Guide in your Control Panel. Press the right-hand mouse button in the hardware tree in Kvaser Device Guide and choose "Locate Hardware (Flash LEDs)" – see Figure 3 on Page 9.

It is also possible to flash an entire Kvaser MagiSync group using the same method in the Synchronized Hardware view. The serial number could be found on the back of the Kvaser Leaf and in Kvaser Device Guide, see Figure 4 on Page 10.



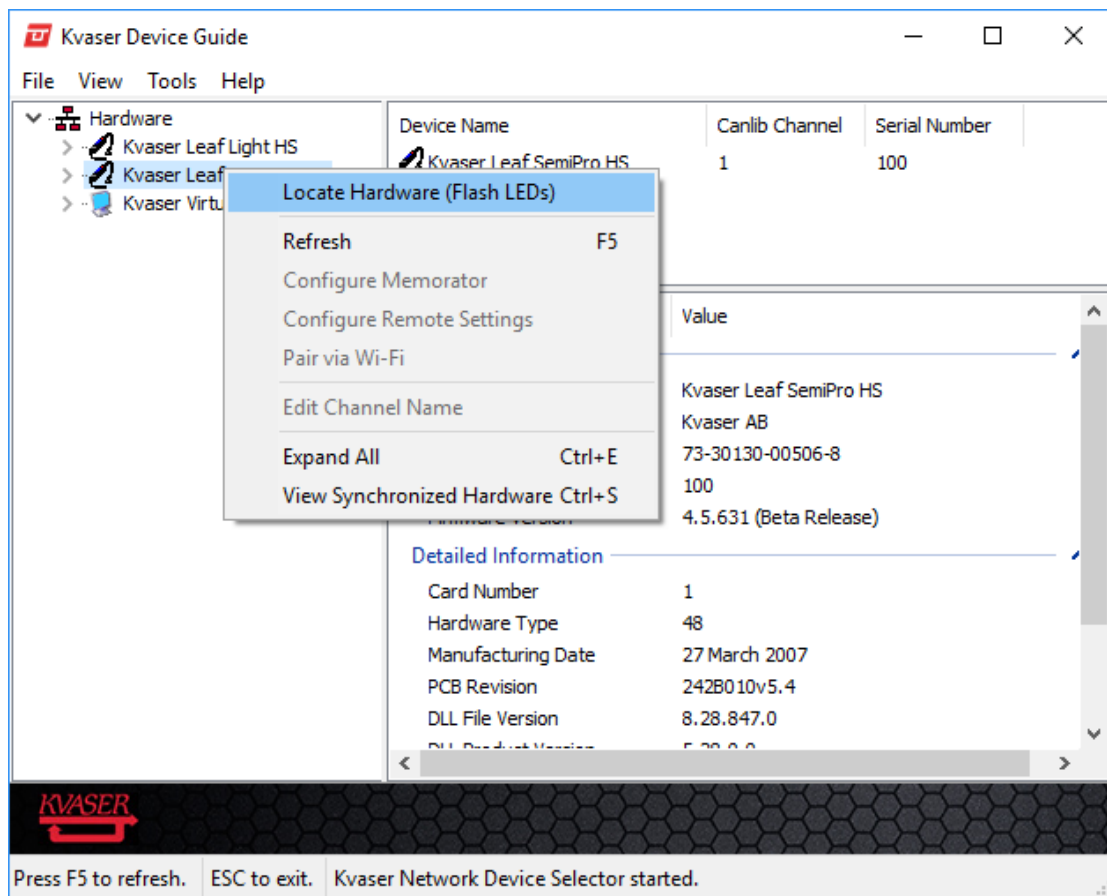

Figure 3: Locate Hardware

Clicking on a device channel opens up a panel with more detailed information, for example serial number, firmware revision, EAN number etc; see Figure 4 on Page 10.

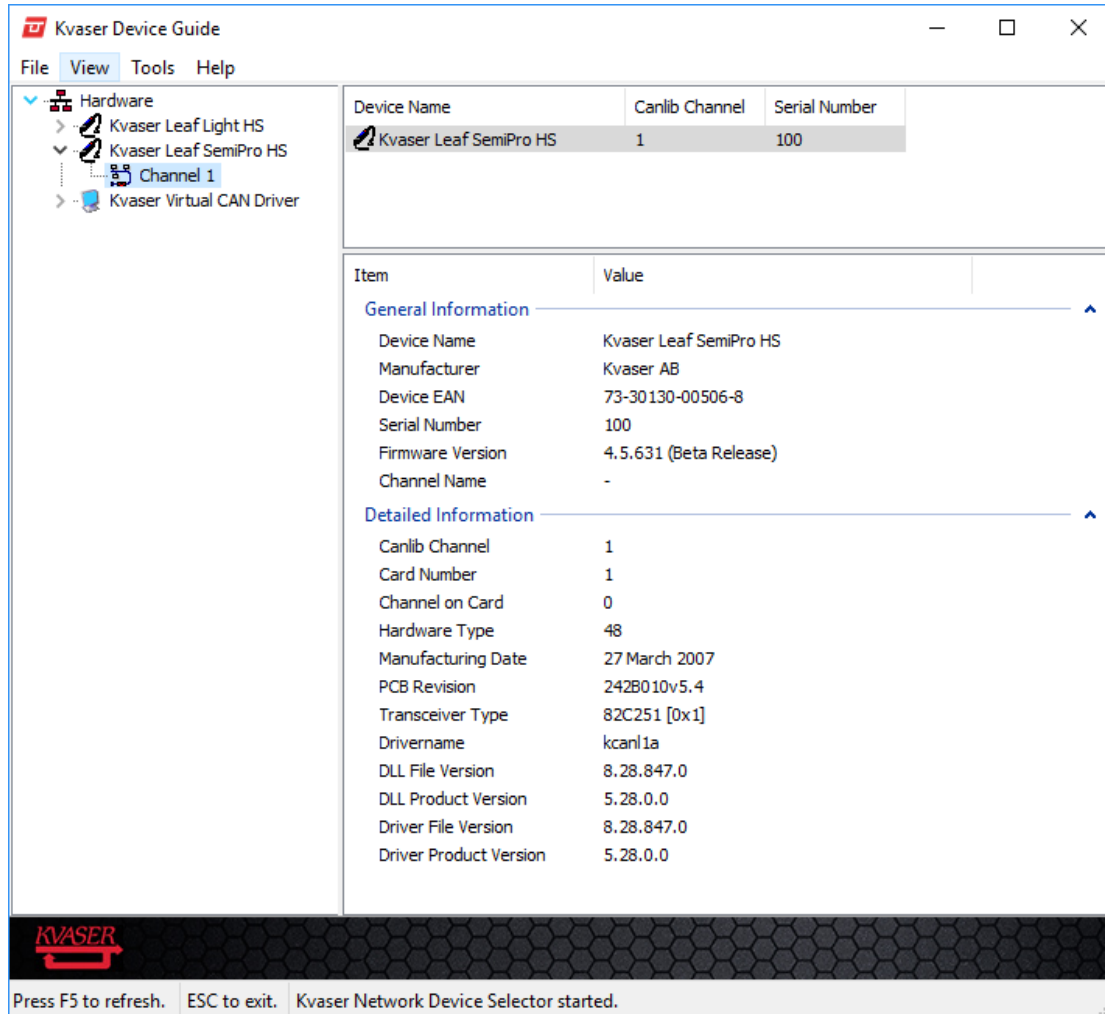

Figure 4: Channel information

For more information and help on using Kvaser Device Guide, press F1 from within the program.

## 2.3 Power

All Kvaser Leaf devices are powered through the USB connector. The host must supply 5 V DC, as per the USB specification. Some device types also need a reference voltage on the CAN or LIN connector. This is described in detail in Section 2.6.2, Reference Power (pin 9), on Page 13.

## 2.4 LEDs

If there is something wrong with the Kvaser Leafs, they will indicate this by flashing the green (power) LED in different ways. See Table 2 on Page 11.

Power LED (Green)	Description
Steady light	Everything is functioning correctly.
One flash every third second.	Something is wrong with the USB connection.
2 Hz flash	Something is wrong with the firmware or configuration.

Table 2: Error flashing

- If the Leaf indicates that something is wrong with the USB connection, check the cables and connectors, and check the device driver. Is it properly installed? Does the Device Manager (in Windows) indicate any problem? Are there any messages in the system event log?
- If the Leaf indicates something is wrong with the firmware or configuration, try to reprogram the firmware. This error can happen if a firmware not matching the hardware type has been programmed.

## 2.5 USB connector

The Kvaser Leaf device may be connected to any free USB socket on the host computer. Power does not have to be turned off before inserting or removing the device. It is good practice, though, to exit all applications using the CAN hardware before removing a Kvaser Leaf device.

The USB cable included with the delivery is approx. 110 cm long and is permanently attached to the Kvaser Leaf. If a longer cable is desired, use a standard extension cable with a type "A" receptacle (Figure 5) at one end and a type "A" plug (Figure 6) at the other end. Do *not* extend the cable to more than 5 m without an active extender. With an active extender, the maximum length is 25 m.



Figure 5: USB Type "A" Receptacle



Figure 6: USB Type "A" Plug

## 2.6 D-SUB connector

The CAN channel has a 9-pin D-SUB plug. The pinning is described in Table 3 on Page 12.

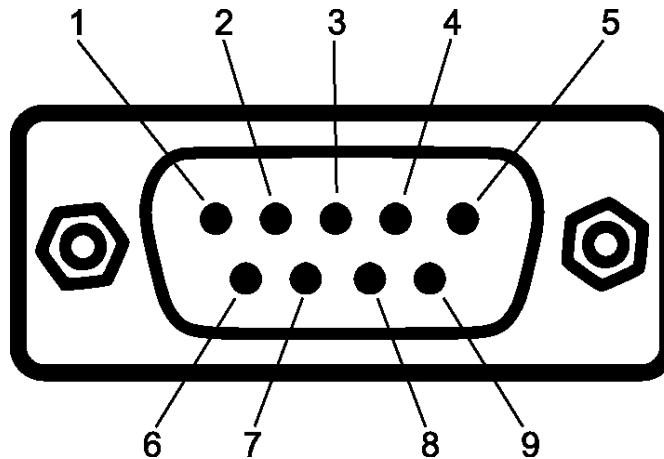

Figure 7: The D-SUB connector pin numbers

D-SUB Pin number	Low Speed	High Speed	SWC	LIN
1	Not connected	Not connected	Not connected	Not connected
2	CAN_L	CAN_L	Not connected	Not connected
3	GND	GND	GND	GND
4	Not connected	Not connected	Pull-down resistor <sup>1</sup>	Not connected
5	Shield	Shield	Shield	Shield
6	Not connected	Not connected	Not connected	Not connected
7	CAN_H	CAN_H	CAN_H	LIN_BUS
8	Not connected	Not connected	Not connected	Not connected
9	Reference power	Not connected	Reference power	Reference power

Table 3: D-SUB pin configuration

### 2.6.1 SWC Leafs only (pin 4))

In high speed mode an external load resistor of  $180\ \Omega$  is required. Pin 4 has an  $180\ \Omega$  resistance connected through a switch to ground (pin 3). When the Kvaser Leaf is configured to "high speed" mode by software, this switch closes. To acquire the needed pull-down resistor, the user needs only connect pin 4 to pin 7; see Figure 8 on Page 13. In other modes, the switch is open and pin 4 will not affect the bus.

<sup>1</sup>See Section 2.6.1 SWC Leafs only (pin 4))

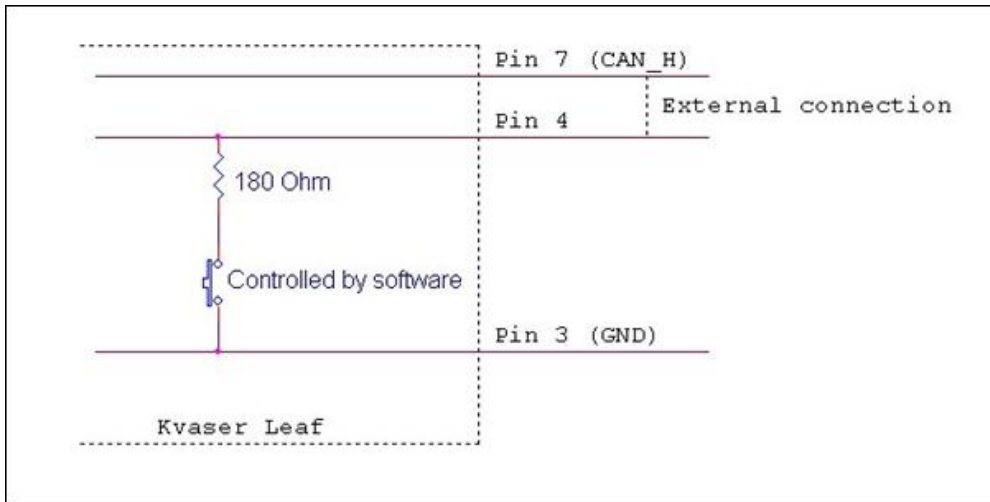

Figure 8: Pin 4 on the SWC Leafs

### 2.6.2 Reference Power (pin 9)

This pin is used only to power the transceiver and as voltage reference. The Kvaser Leaf itself is powered through the USB connector and does not draw any current from this pin.

#### **Kvaser Leaf HS:**

This pin is not connected.

#### **Kvaser Leaf LS:**

Connect the battery voltage to this pin. It is used by the transceiver to detect whether CAN\_H and/or CAN\_L are shorted to the system voltage. It may be omitted but the transceiver will then not detect a short circuit properly. The operating input voltage range is 6 V to 27 V (absolute maximum rating is 40 V). The input is protected from load dumps.

#### **Kvaser Leaf SWC:**

Connect the battery voltage to this pin. It is used as a reference voltage when transmitting and receiving WAKEUP frames. It **must** be connected to ensure proper behaviour of the transceiver. The operating input voltage range is 6 V to 27 V (absolute maximum rating is 40 V). The input is protected from load dumps.

#### **Kvaser Leaf LIN:**

Connect the battery voltage to this pin. It is used as a reference voltage and to power the transceiver. It **must** be connected to ensure proper behaviour of the transceiver. The operating input voltage range is 6 V to 18 V for older devices, while for devices with serial number 10200 or higher, the operating input voltage range is 6 V to 27 V (absolute maximum rating is 40 V). The input is protected from load dumps. The Kvaser Leaf will automatically switch the pull-up from 30 k $\Omega$  to 1 k $\Omega$  when you go from slave mode to master mode; see Figure 9 on Page 14.

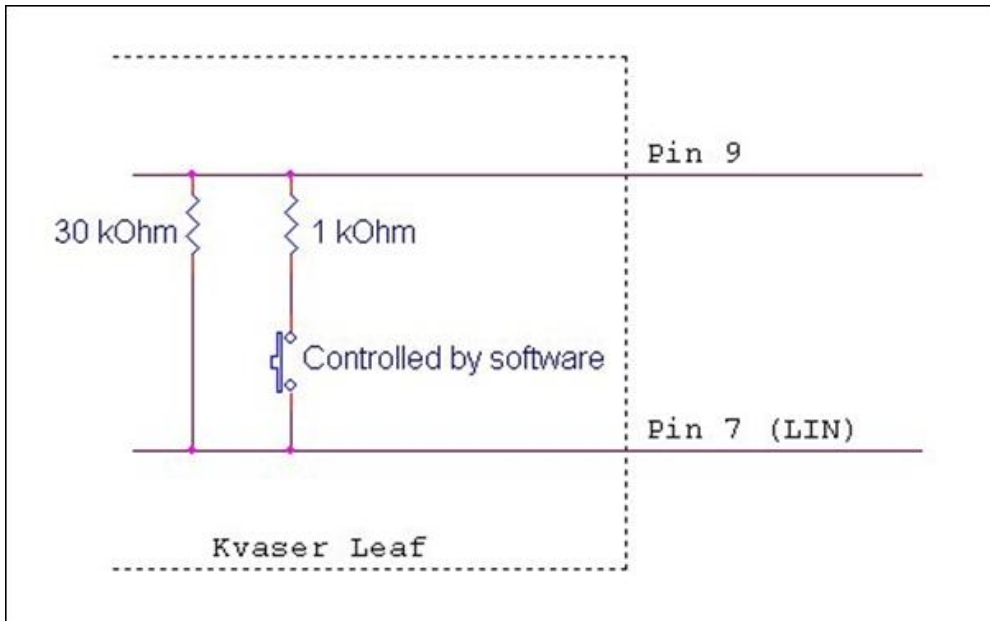

Figure 9: Pull up resistors on the LIN Leaf

### 2.6.3 CAN Bus Termination

The Kvaser Leaf devices do not have built-in termination.

You must ensure your CAN bus have appropriate termination, or the communication may be unreliable.

#### 2.6.3.1 Terminating a High-Speed CAN bus

A high-speed (ISO 11898-2) CAN bus is terminated by placing a  $120\ \Omega$  resistor in each end of the CAN bus. The resistors connect CAN\_H to CAN\_L.

In a lab environment, with short CAN buses, it might be sufficient with only one terminator.

A high-speed CAN bus without any termination at all **will not work**.

#### 2.6.3.2 Terminating a Low-Speed CAN bus

A low-speed (ISO 11898-3) CAN bus does not have any termination proper. Instead each module on the CAN bus has a pull-up resistor from CAN\_L to +5 V, and a pull-down resistor from CAN\_H to signal ground. The net resistance of all pull-up resistors should be  $200\ \Omega$ , and the same holds true for the net resistance of all pull-down resistors in the system.

The low-speed Kvaser Leafs have built-in pull-up and pull-down resistors of  $4700\ \Omega$ . This value is chosen as to load the system as little as possible. You will probably need to add extra pull-up and pull-down resistors to the CAN bus unless the system you connect the Kvaser Leaf to already has a proper resistor configuration.

### 2.6.3.3 Terminating a Single-Wire CAN bus

The single-wire (SAE J2411) CAN bus does not have any termination. When running the SWC bus in its high-speed mode, a load resistance of  $180\ \Omega$  from CAN\_H to ground is required.

Every Single-Wire CAN driver has a small load between the CAN bus line and ground. In the Kvaser Leaf, it is  $9100\ \Omega$ . The load current through this resistor will be used to detect a disconnected ground wire. When running the SWC bus in its high-speed mode, a load resistance of  $180\ \Omega$  from CAN\_H to ground is required. The Kvaser Leaf hardware supports high-speed as a master and has an internal  $180\ \Omega$  which is automatically switched in when required, as seen in Figure 8 on Page 13.

## 2.7 OBDII Connector

The CAN channel has a 16-pin OBDII plug. The pinning is described in Table 4.

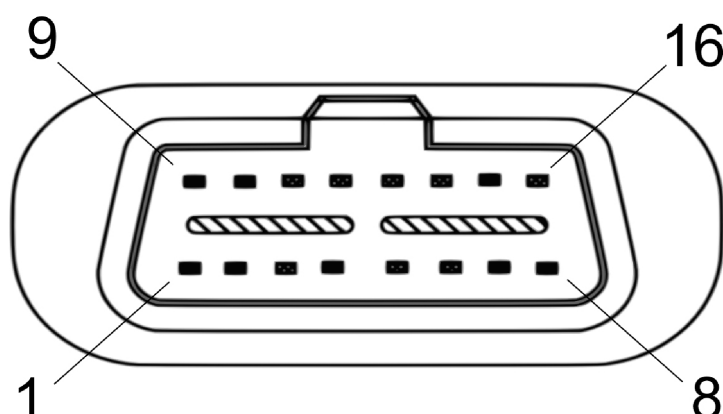

Figure 10: OBDII Connector pin Numbers

OBDII Pin number	Kvaser Leaf Professional HS with OBDII connector
4	Shield
5	GND
6	CAN_H
14	CAN_L
16	Reference power (not used)

Table 4: OBDII pin configuration (showing only connected pin)

## 2.8 J1939-13 Connector

The CAN channel has a 9-pin J1939 plug. The pinning is described in Table 5 on Page 16.

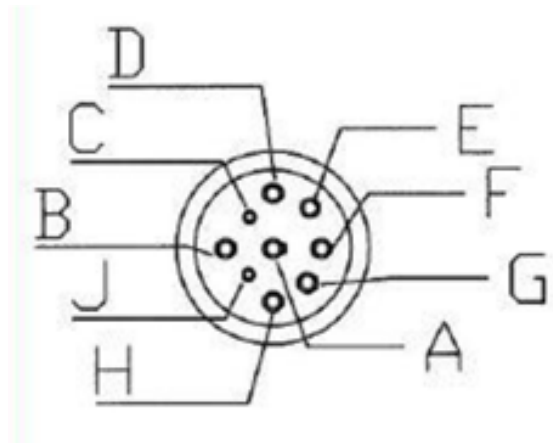

Figure 11: J1939-13 Connector pins

J1939-13 Pin	Kvaser Leaf Leaf Light with J1939-13 connector
A	GND
B	Not connected
C	CAN_HI
D	CAN_LOW
E	SHIELD
F-J	Not connected

Table 5: J1939-13 pin configuration



## 2.9 Technical data common to all Kvaser Leaf products

Property	Description
<b>CAN channels</b>	1 (CAN 2.0A and 2.0B active)
<b>Error frame detection</b>	Yes
<b>Kvaser t programming</b>	No
<b>Hardware requirements</b>	IBM PC AT or 100 % compatible; USB host socket
<b>USB interface</b>	USB 2.0 or USB 1.1
<b>Power consumption</b>	5 V and approx. 70 mA powered from the USB side
<b>Software requirements</b>	Windows (7 or later), Linux <sup>a</sup> .
<b>Configuration</b>	Done by software (Plug & Play)
<b>Mix 11 / 29 bits messages</b>	Yes
<b>CAN Connector</b>	9-pin male D-SUB
<b>USB cable length</b>	110 cm (approx. 3.6 ft)
<b>USB connector</b>	USB standard type "A" plug
<b>CAN cable length</b>	30 cm (1 ft)
<b>Load dump protection</b>	Yes
<b>Dimensions (W*L*H)<sup>b</sup></b>	25 x 100 x 20 (mm) ca. 1 x 4 x 0.9 (inches)
<b>Housing<sup>b</sup></b>	Black plastic
<b>Weight<sup>b</sup></b>	105 g
<b>Dimensions (W*L*H)<sup>c</sup></b>	30 x 160 x 20 (mm) ca. 1.2 x 6.3 x 0.8 (inches)
<b>Housing<sup>c</sup></b>	Black anodized aluminium
<b>Weight<sup>c</sup></b>	155 g

Table 6: Technical data for all Kvaser Leafs

## 3 Kvaser Leaf Light HS

### 3.1 Introduction

Kvaser Leaf Light is a reliable low cost product. With a time stamp precision of 100  $\mu$ s it handles transmission and reception of standard and extended CAN messages on the bus.

<sup>a</sup>For more information, contact Kvaser support.

<sup>b</sup>All products except for the "Rugged" types

<sup>c</sup>All "Rugged" product types



Figure 12: Kvaser Leaf Light

### 3.2 LEDs

The Kvaser Leaf Light has two LEDs. Their functions are shown in Table 7.

LED	Function	Description
LED 1 Green	Power	Active when the Kvaser Leaf is powered.
LED 2 Yellow	CAN Rx/Tx	Active when messages are being sent or received.

Table 7: Kvaser Leaf Light LED configuration

### 3.3 Technical data

Technical data exclusive to Kvaser Leaf Light HS are listed in Table 8 on Page 19: Technical data for Kvaser Leaf Light HS. For common technical data for all Kvaser Leaf Leaf products, see Table 6 on Page 17: Technical data for all Kvaser Leafs.

Property	Description	Unit
CAN physical layer	High speed (ISO 11898-2)	
USB speed	12	Mbit/s
Bit rate	5-1000	kbit/s
Temperature range	-20 to +75	°C
Clock accuracy	100	µs
Max message rate	8000	Messages/s
Time stamp	32	bits
OBDII Connector	Optional <sup>a</sup>	
J1939-13 Connector	Optional <sup>b</sup>	
Galvanic isolation	Optional <sup>c</sup>	

Table 8: Technical data for Kvaser Leaf Light HS

---

<sup>a</sup>With Kvaser Leaf Light OBDII<sup>b</sup>With Kvaser Leaf Light J1939-13<sup>c</sup>With Kvaser Leaf Light Galvanic Isolation

## 4 Kvaser Leaf Light Rugged

### 4.1 Introduction

Kvaser Leaf Light Rugged is a one channel USB interface for CAN. In hostile environments where dust and water are the norm, the IP67 rated housing assures reliable protection.



Figure 13: Kvaser Leaf Light Rugged

### 4.2 LEDs

The Kvaser Leaf Light Rugged has two LEDs. Their functions are shown in Table 9.

LED	Function	Description
LED 1 Green	Power	Active when the Kvaser Leaf is powered.
LED 2 Yellow	CAN Rx/Tx	Active when messages are being sent or received.

Table 9: Kvaser Leaf Light Rugged LED configuration

### 4.3 Technical Data

Technical data exclusive to Kvaser Leaf Light Rugged HS are listed in Table 10 on Page 21: Specifications for data for Kvaser Leaf rugged. For common technical data for all Kvaser Leaf Leaf products, see Table 6 on Page 17: Technical data for all Kvaser Leafs.

Property	Description	Unit
<b>CAN physical layer</b>	High speed (ISO 11898-2)	
<b>Bit rate</b>	5–1000	kbit/s
<b>Temperature range</b>	-40 to +85	°C
<b>Max message rate</b>	8000	Messages/s
<b>USB speed</b>	12	Mbit/s
<b>Clock accuracy</b>	100	µs
<b>Time stamp</b>	32	bits
<b>Galvanic isolation</b>	Yes	
<b>Polyurethane cabling</b>	Yes	
<b>IP Rating</b>	IP 67	

Table 10: Specifications for Kvaser Leaf Light Rugged

## 5 Kvaser Leaf SemiPro LS/HS/SWC

### 5.1 Introduction

Kvaser Leaf SemiPro is a product with high and reliable performance. With the patented Kvaser MagiSync™, all Kvaser Leaf SemiPro and Kvaser Leaf Professional connected to the same USB hub are synchronized to a virtual global clock, common for all time stamps.



Figure 14: Kvaser Leaf SemiPro

### 5.2 LEDs

The Kvaser Leaf SemiPro has three LEDs. The functionality is presented in Table 11.

LED	Function	Description
LED 1 Green	Power	Active when the Kvaser Leaf is powered.
LED 2 Yellow	CAN Rx/Tx	Active when CAN messages are being sent or received.
LED 3 Red	Error	Active when CAN error frames are detected. On the Kvaser Leaf SemiPro LS, it is also active when the NERR signal is active from the transceiver is active.

Table 11: Kvaser Leaf SemiPro LED configuration

### 5.3 Technical Data

Technical data exclusive to Kvaser Leaf SemiPro LS/HS/SWC are listed in Table 14 on Page 25. For common technical data for all Kvaser Leaf Leaf products, see Table 6 on Page 17: Technical data for all Kvaser Leafs.

Property	Kvaser Leaf SemiPro LS	Kvaser Leaf SemiPro HS	Kvaser Leaf SemiPro SWC	Unit
<b>CAN physical layer</b>	Low speed (ISO 11898-3)	High speed (ISO 11898-2)	SWC (SAE J2411)	
<b>Bit rate</b>	5-125	5-1000	5-50/100	kbit/s
<b>Temperature range</b>	-40 to +85	-40 to +85	-40 to +85	°C
<b>Max message rate</b>	2500	15000	2000	Msgs/s
<b>USB speed</b>	12 & 480	12 & 480	12 & 480	Mbit/s
<b>Clock accuracy</b>	25	25	25	µs
<b>Time stamp</b>	32	32	32	bits
<b>Galvanic isolation</b>	Yes	Yes	Yes	
<b>Clock sync of multiple devices</b>	Yes	Yes	Yes	
<b>Error frame generation</b>	Yes	Yes	Yes	
<b>Silent mode</b>	Yes	Yes	Yes	
<b>Polyurethane cabling</b>	Yes	Yes	Yes	

Table 12: Technical data for Kvaser Leaf SemiPro LS/HS/SWC

## 6 Kvaser Leaf SemiPro Rugged

### 6.1 Introduction

Kvaser Leaf SemiPro is a one channel USB interface for CAN. In hostile environments where dust and water are the norm, the IP67 rated housing assures reliable protection.



Figure 15: Kvaser Leaf SemiPro Rugged

### 6.2 LEDs

The Kvaser Leaf SemiPro Rugged has three LEDs. The functionality is presented in Table 13.

LED	Function	Description
LED 1 Green	Power	Active when the Kvaser Leaf is powered.
LED 2 Yellow	CAN Rx/Tx	Active when CAN messages are being sent or received.
LED 3 Red	Error	Active when CAN error frames are detected.

Table 13: Kvaser Leaf SemiPro Rugged LED configuration

### 6.3 Technical Data

Technical data exclusive to Kvaser Leaf SemiPro Rugged are listed in Table 14 on Page 25. For common technical data for all Kvaser Leaf Leaf products, see Table 6 on Page 17: Technical data for all Kvaser Leafs.



Property	Kvaser Leaf SemiPro Rugged HS	Unit
<b>CAN physical layer</b>	High speed (ISO 11898-2)	
<b>Bit rate</b>	5–1000	kbit/s
<b>Temperature range</b>	-40 to +85	°C
<b>Max message rate</b>	15000	Msgs/s
<b>USB speed</b>	12 & 480	Mbit/s
<b>Clock accuracy</b>	25	µs
<b>Time stamp</b>	32	Bits
<b>Galvanic isolation</b>	Yes	
<b>Clock sync of multiple devices</b>	Yes	
<b>Error frame generation</b>	Yes	
<b>Silent mode</b>	Yes	
<b>Polyurethane cabling</b>	Yes	
<b>IP Rating</b>	IP 67	

Table 14: Technical data for Kvaser Leaf SemiPro LS/HS/SWC

## 7 Kvaser Leaf Professional LS/HS/SWC/LIN

### 7.1 Introduction

Kvaser Leaf Professional is designed for high end applications that require high performance, accurate time stamping and Kvaser MagiSync™ synchronisation. It is perfect for advanced CAN bus analysers, data loggers and other applications.



Figure 16: Kvaser Leaf Professional

### 7.2 LEDs

The Kvaser Leaf Professional has four LEDs. The functionality is presented in Table 15.

LED	Function	Description
LED 1 Green	Power	Active when the Kvaser Leaf is powered.
LED 2 Yellow	CAN Tx	Active when CAN messages are being sent.
LED 3 Yellow	CAN Rx	Active when CAN messages are being received.
LED 4 Red	Error	Active when CAN error frames are detected. On the Kvaser Leaf Professional LS, it is also active when the NERR signal is active from the transceiver is active.

Table 15: Kvaser Leaf Professional LEDs

### 7.3 Technical data

Technical data exclusive to Kvaser Leaf Professional LS/HS/SWC are listed in Table 16 on Page 27 and to Kvaser Leaf Professional LIN in Table 17 on Page 28. For common technical data for all Kvaser Leaf Leaf products, see Table 6 on Page 17: Technical data for all Kvaser Leafs.

Property	Kvaser Leaf Professional LS	Kvaser Leaf Professional HS	Kvaser Leaf Professional SWC	Unit
<b>CAN physical layer</b>	Low speed (ISO 11898-3)	High speed (ISO 11898-2)	SWC (SAE J2411)	
<b>Bit rate</b>	5–125	5–1000	5–50/100	kbit/s
<b>Temperature range</b>	-40 to +85	-40 to +85	-40 to +85	°C
<b>Max message rate</b>	2000	15000	2500	Msgs/s
<b>USB speed</b>	12 & 480	12 & 480	12 & 480	Mbit/s
<b>Clock accuracy</b>	1	1	1	µs
<b>Time stamp</b>	32/64	32/64	32/64	bits
<b>Clock sync of multiple devices</b>	Yes	Yes	Yes	
<b>Galvanic isolation</b>	Yes	Yes	Yes	
<b>Error frame generation</b>	Yes	Yes	Yes	
<b>Sound indicator</b>	Yes	Yes	Yes	
<b>Silent mode</b>	Yes	Yes	Yes	
<b>Auto transmit buffers</b>	Yes	Yes	Yes	
<b>Auto receive buffers</b>	Yes	Yes	Yes	
<b>Polyurethane cabling</b>	Yes	Yes	Yes	
<b>OBDII Connector</b>	-	Optional <sup>a</sup>	-	

Table 16: Technical data for Kvaser Leaf Professional LS/HS/SWC

<sup>a</sup>With Kvaser Leaf Professional HS with OBDII connector

Property	Kvaser Leaf Professional LIN	Unit
LIN specification	2.0 and 1.X	
Bit rate	1–20	kbit/s
Temperature range	-40 to +85	°C
USB speed	12 and 480	Mbit/s
Clock accuracy	1	µs
Time stamp	32/64	bits
Clock sync of multiple devices	Yes – also between Kvaser Leaf Professional LS/HS/SWC	
Galvanic isolation	Yes	
Sound indicator	Yes	
Normal/Sleep Mode	Yes	
Monitor Mode	Yes	
Master/Slave Mode	Yes	
Auto transmit buffers	Yes	
Auto receive buffers	Yes	
Polyurethane cabling	Yes	

Table 17: Technical data for Kvaser Leaf Professional LIN

## 8 Kvaser Leaf Professional Rugged

### 8.1 Introduction

Kvaser Leaf Professional Rugged is a one channel USB interface for CAN. In hostile environments where dust and water are the norm, the IP67 rated housing assures reliable protection.



Figure 17: Kvaser Leaf Professional Rugged

### 8.2 LEDs

The Kvaser Leaf Professional Rugged has four LEDs. Their functions are shown in Table 18.

LED	Function	Description
LED 1 Green	Power	Active when the Kvaser Leaf is powered.
LED 2 Yellow	CAN Tx	Active when CAN messages are being sent.
LED 3 Yellow	CAN Rx	Active when CAN messages are being received.
LED 4 Red	Error	Active when CAN error frames are being detected.

Table 18: Kvaser Leaf Professional Rugged, LEDs

### 8.3 Technical Data

Technical data exclusive to Kvaser Leaf Professional Rugged HS are listed in Table 19 on Page 30: Specifications for Kvaser Leaf Professional Rugged. For common technical data for all Kvaser Leaf Leaf products, see Table 6 on Page 17: Technical data for all Kvaser Leafs.

Property	Kvaser Leaf Professional HS	Unit
<b>CAN physical layer</b>	High speed (ISO 11898-2)	
<b>Bit rate</b>	5–1000	kbit/s
<b>Temperature range</b>	-40 to +85	°C
<b>Max message rate</b>	20000	Msgs/s
<b>USB speed</b>	12 and 480	Mbit/s
<b>Clock accuracy</b>	1	µs
<b>Time stamp</b>	32/64	bits
<b>Clock sync of multiple devices</b>	Yes	
<b>Galvanic isolation</b>	Yes	
<b>Error frame generation</b>	Yes	
<b>Sound indicator</b>	Yes	
<b>Silent mode</b>	Yes	
<b>Auto transmit buffers</b>	Yes	
<b>Auto receive buffers</b>	Yes	
<b>Polyurethane cabling</b>	Yes	
<b>IP Rating</b>	IP 67	

Table 19: Specifications for Kvaser Leaf Professional Rugged

## 9 Frequently Asked Questions

### ***How many Kvaser Leafs can I connect to my computer?***

The theoretical maximum is 127 per USB controller. The present limit, set by the software is 16. If you want to connect more Kvaser Leafs, please contact our support department.

### ***Could I use several hubs?***

Yes, but the Kvaser Leafs must be on the same root hub for the Kvaser MagiSync™ to work. For more information, see Section 1.1, Kvaser MagiSync™, on Page 5.

### ***If I reboot my computer, will the Kvaser Leafs and other products have the same channel numbers as before?***

Yes, they will try to reuse the old channel numbers. For more information see Section 2.2, Identification, on Page 8, Identification.

### ***How can I identify which Kvaser Leaf has a certain channel number?***

Use “Kvaser Device Guide” to flash the LEDs on the Kvaser Leaf. For more information see Section 2.2, Identification, on Page 8.

### ***How do I know which Kvaser Leafs are synchronized?***

Use “Kvaser Device Guide” to flash the LEDs on an entire MagiSync™ group. For more information see Section 2.2, Identification, on Page 8

### ***Do I have to use an external hub to keep the Leafs synchronized?***

No, you don't. See Section 1.1, Kvaser MagiSync™, on Page 5.

### ***As far as I remember pin 7 was not connected on the Kvaser DRVcan LIN so I can connect pin 7 and pin 4 on my LIN bus in order to work with both kinds of cables. Is that correct?***

Yes. For more information about LIN, please contact our support department.

## 10 Support and software updates

Visit our homepage [www.kvaser.com/](http://www.kvaser.com/) to find more FAQs and other helpful information.

**Support email:**

[support@kvaser.com](mailto:support@kvaser.com)

### 10.1 Driver installation

For driver installation and firmware update see the driver installation documentation.

### 10.2 Firmware Updates

Firmware updates and upgrade instructions can be found at [www.kvaser.com/download](http://www.kvaser.com/download)

Use “Kvaser Device Guide” to see the present firmware version of your Kvaser Leaf.

### 10.3 Driver Updates

Driver updates and upgrade instructions can be found at [www.kvaser.com/download](http://www.kvaser.com/download)

Use “Kvaser Device Guide” to see the present firmware version of your Kvaser Leaf.



# 11 Safety Instructions

## 11.1 Intended Use

Kvaser interfaces are used to connect computer systems to CAN buses. The Kvaser Leaf is intended for connection to a computer via the USB port.

## 11.2 Usage Warning



### WARNING FOR ALL USERS

WARNING! - YOUR USE OF THIS DEVICE MUST BE DONE WITH CAUTION AND A FULL UNDERSTANDING OF THE RISKS!

THIS WARNING IS PRESENTED TO INFORM YOU THAT THE OPERATION OF THIS DEVICE MAY BE DANGEROUS. YOUR ACTIONS CAN INFLUENCE THE BEHAVIOR OF A CAN-BASED DISTRIBUTED EMBEDDED SYSTEM, AND DEPENDING ON THE APPLICATION, THE CONSEQUENCES OF YOUR IMPROPER ACTIONS COULD CAUSE SERIOUS OPERATIONAL MALFUNCTION, LOSS OF INFORMATION, DAMAGE TO EQUIPMENT, AND PHYSICAL INJURY TO YOURSELF AND OTHERS. A POTENTIALLY HAZARDOUS OPERATING CONDITION IS PRESENT WHEN THE FOLLOWING TWO CONDITIONS ARE CONCURRENTLY TRUE: THE PRODUCT IS PHYSICALLY INTERCONNECTED TO A REAL DISTRIBUTED EMBEDDED SYSTEM; AND THE FUNCTIONS AND OPERATIONS OF THE REAL DISTRIBUTED EMBEDDED SYSTEM ARE CONTROLLABLE OR INFLUENCED BY THE USE OF THE CAN NETWORK. A POTENTIALLY HAZARDOUS OPERATING CONDITION MAY RESULT FROM THE ACTIVITY OR NON-ACTIVITY OF SOME DISTRIBUTED EMBEDDED SYSTEM FUNCTIONS AND OPERATIONS, WHICH MAY RESULT IN SERIOUS PHYSICAL HARM OR DEATH OR CAUSE DAMAGE TO EQUIPMENT, DEVICES, OR THE SURROUNDING ENVIRONMENT.

WITH THIS DEVICE, YOU MAY POTENTIALLY:

- CAUSE A CHANGE IN THE OPERATION OF THE SYSTEM, MODULE, DEVICE, CIRCUIT, OR OUTPUT.
- TURN ON OR ACTIVATE A MODULE, DEVICE, CIRCUIT, OUTPUT, OR FUNCTION.
- TURN OFF OR DEACTIVATE A MODULE, DEVICE, CIRCUIT, OUTPUT, OR FUNCTION.
- INHIBIT, TURN OFF, OR DEACTIVATE NORMAL OPERATION.
- MODIFY THE BEHAVIOR OF A DISTRIBUTED PRODUCT.
- ACTIVATE AN UNINTENDED OPERATION.
- PLACE THE SYSTEM, MODULE, DEVICE, CIRCUIT, OR OUTPUT INTO AN UNINTENDED MODE.

ONLY THOSE PERSONS WHO:

(A) ARE PROPERLY TRAINED AND QUALIFIED WITH RESPECT TO THE USE OF THE DEVICE,

(B) UNDERSTAND THE WARNINGS ABOVE, AND

(C) UNDERSTAND HOW THIS DEVICE INTERACTS WITH AND IMPACTS THE FUNCTION AND SAFETY OF OTHER PRODUCTS IN A DISTRIBUTED SYSTEM AND THE APPLICATION FOR WHICH THIS DEVICE WILL BE APPLIED, MAY USE THE DEVICE.

PLEASE NOTE THAT YOU CAN INTEGRATE THIS PRODUCT AS A SUBSYSTEM INTO HIGHER-LEVEL SYSTEMS. IN CASE YOU DO SO, KVASER AB HEREBY DECLARES THAT KVASER AB'S WARRANTY SHALL BE LIMITED TO THE CORRECTION OF DEFECTS, AND KVASER AB HEREBY EXPRESSLY DISCLAIMS ANY LIABILITY OVER AND ABOVE THE REFUNDING OF THE PRICE PAID FOR THIS DEVICE, SINCE KVASER AB DOES NOT HAVE ANY INFLUENCE ON THE IMPLEMENTATIONS OF THE HIGHER-LEVEL SYSTEM, WHICH MAY BE DEFECTIVE.

## 12 Disposal and Recycling Information



When this product reaches its end of life, please dispose of it according to your local environmental laws and guidelines.

For information about Kvaser's recycling programs, visit:  
<https://www.kvaser.com/en/kvaser/recycling-policy.html>

## 13 Legal information

### 13.1 Electromagnetic compability

All Kvaser Leafs are CE-marked and tested according to the appropriate standards. This device complies with Part 15 of the FCC Rules. Operation is subject to the following two conditions: (1) this device may not cause harmful interference, and (2) this device must accept any interference received, including interference that may cause undesired operation.

## 13.2 EU Regulatory Compliance



### EU Declaration of Conformity (DoC)

**We**

Company Name:	Kvaser AB	City:	Mölnadal
Postal address:	Aminogatan 25	Telephone number:	+46 31 886344
Postcode:	431 53	E-mail address:	sales@kvaser.com

**declare that the DoC is issued under our sole responsibility and belongs to the following product:**

Product: Kvaser Leaf Light HS

**Object of the declaration** (identification of apparatus allowing traceability):

Product: Kvaser Leaf Light HS

Type: 73-30130-00241-8

**The object of the declaration described above is in conformity with the relevant Union harmonisation legislation:**

DIRECTIVE 2004/108/EC OF THE EUROPEAN PARLIAMENT AND OF THE COUNCIL of 15 December 2004 (EMC-directive)

RoHS recast Directive 2011/65/EU (Art. 4.1)

**The following harmonised standards and technical specifications have been applied** (title, date of standard/specification):

EN 50581 (2012)

**Signed for and on behalf of:**

Mölnadal

2019-12-05

Place of issue

Date of issue

Claes Haglund, Supply Chain and Quality Director



## EU Declaration of Conformity (DoC)

**We**

Company Name:	Kvaser AB	City:	Möln dal
Postal address:	Aminogatan 25	Telephone number:	+46 31 886344
Postcode:	431 53	E-mail address:	sales@kvaser.com

**declare that the DoC is issued under our sole responsibility and belongs to the following product:**

Product: Kvaser Leaf Semipro HS

**Object of the declaration** (identification of apparatus allowing traceability):

Product: Kvaser Leaf Semipro HS

Type: 73-30130-00242-5

**The object of the declaration described above is in conformity with the relevant Union harmonisation legislation:**

DIRECTIVE 2004/108/EC OF THE EUROPEAN PARLIAMENT AND OF THE COUNCIL of 15 December 2004 (EMC-directive)

RoHS recast Directive 2011/65/EU (Art. 4.1)

**The following harmonised standards and technical specifications have been applied**

(title, date of standard/specification):

EN 50581 (2012)

**Signed for and on behalf of:**

Möln dal

2019-12-05

Place of issue

Date of issue

Claes Haglund, Supply Chain and Quality Director



## EU Declaration of Conformity (DoC)

## We

Company Name:	Kvaser AB	City:	Möln dal
Postal address:	Aminogatan 25	Telephone number:	+46 31 886344
Postcode:	431 53	E-mail address:	sales@kvaser.com

declare that the DoC is issued under our sole responsibility and belongs to the following product:

Product: Kvaser Leaf Professional HS

**Object of the declaration** (identification of apparatus allowing traceability):

Product: Kvaser Leaf Professional HS

Type: 73-30130-00243-2

**The object of the declaration described above is in conformity with the relevant Union harmonisation legislation:**

DIRECTIVE 2004/108/EC OF THE EUROPEAN PARLIAMENT AND OF THE COUNCIL of 15 December 2004 (EMC-directive)

RoHS recast Directive 2011/65/EU (Art. 4.1)

**The following harmonised standards and technical specifications have been applied**

(title, date of standard/specification):

EN 50581 (2012)

Signed for and on behalf of:

Möln dal

2019-12-05

Place of issue

Date of issue

  
Claes Haglund, Supply Chain and Quality Director



## EU Declaration of Conformity (DoC)

## We

Company Name:	Kvaser AB	City:	Mölndal
Postal address:	Aminogatan 25	Telephone number:	+46 31 886344
Postcode:	431 53	E-mail address:	sales@kvaser.com

declare that the DoC is issued under our sole responsibility and belongs to the following product:

Product: Kvaser Leaf Semipro LS

**Object of the declaration** (identification of apparatus allowing traceability):

Product: Kvaser Leaf Semipro LS

Type: 73-30130-00260-9

**The object of the declaration described above is in conformity with the relevant Union harmonisation legislation:**

DIRECTIVE 2004/108/EC OF THE EUROPEAN PARLIAMENT AND OF THE COUNCIL of 15 December 2004 (EMC-directive)

RoHS recast Directive 2011/65/EU (Art. 4.1)

**The following harmonised standards and technical specifications have been applied**

(title, date of standard/specification):

EN 50581 (2012)

Signed for and on behalf of:

Mölndal

2019-12-05

Place of issue

Date of issue

  
Claes Haglund, Supply Chain and Quality Director



## EU Declaration of Conformity (DoC)

## We

Company Name:	Kvaser AB	City:	Mölndal
Postal address:	Aminogatan 25	Telephone number:	+46 31 886344
Postcode:	431 53	E-mail address:	sales@kvaser.com

**declare that the DoC is issued under our sole responsibility and belongs to the following product:**

Product: Kvaser Leaf Professional LS

**Object of the declaration** (identification of apparatus allowing traceability):

Product: Kvaser Leaf Professional LS

Type: 73-30130-00261-6

**The object of the declaration described above is in conformity with the relevant Union harmonisation legislation:**

DIRECTIVE 2004/108/EC OF THE EUROPEAN PARLIAMENT AND OF THE COUNCIL of 15 December 2004 (EMC-directive)

RoHS recast Directive 2011/65/EU (Art. 4.1)

**The following harmonised standards and technical specifications have been applied**

(title, date of standard/specification):

EN 50581 (2012)

**Signed for and on behalf of:**

Mölndal

2019-12-05

Place of issue

Date of issue

  
Claes Haglund, Supply Chain and Quality Director



## EU Declaration of Conformity (DoC)

## We

Company Name:	Kvaser AB	City:	Möln dal
Postal address:	Aminogatan 25	Telephone number:	+46 31 886344
Postcode:	431 53	E-mail address:	sales@kvaser.com

declare that the DoC is issued under our sole responsibility and belongs to the following product:

Product: Kvaser Leaf Semipro SWC

**Object of the declaration** (identification of apparatus allowing traceability):

Product: Kvaser Leaf Semipro SWC

Type: 73-30130-00263-0

**The object of the declaration described above is in conformity with the relevant Union harmonisation legislation:**

DIRECTIVE 2004/108/EC OF THE EUROPEAN PARLIAMENT AND OF THE COUNCIL of 15 December 2004 (EMC-directive)

RoHS recast Directive 2011/65/EU (Art. 4.1)

**The following harmonised standards and technical specifications have been applied**

(title, date of standard/specification):

EN 50581 (2012)

Signed for and on behalf of:

Möln dal

2019-12-05

Place of issue

Date of issue

  
Claes Haglund, Supply Chain and Quality Director





## EU Declaration of Conformity (DoC)

## We

Company Name:	Kvaser AB	City:	Möln dal
Postal address:	Aminogatan 25	Telephone number:	+46 31 886344
Postcode:	431 53	E-mail address:	sales@kvaser.com

declare that the DoC is issued under our sole responsibility and belongs to the following product:

Product: Kvaser Leaf Professional SWC

**Object of the declaration** (identification of apparatus allowing traceability):

Product: Kvaser Leaf Professional SWC

Type: 73-30130-00264-7

**The object of the declaration described above is in conformity with the relevant Union harmonisation legislation:**

DIRECTIVE 2004/108/EC OF THE EUROPEAN PARLIAMENT AND OF THE COUNCIL of 15 December 2004 (EMC-directive)

RoHS recast Directive 2011/65/EU (Art. 4.1)

**The following harmonised standards and technical specifications have been applied**

(title, date of standard/specification):

EN 50581 (2012)

Signed for and on behalf of:

Möln dal

2019-12-05

Place of issue

Date of issue

  
Claes Haglund, Supply Chain and Quality Director



## EU Declaration of Conformity (DoC)

**We**

Company Name:	Kvaser AB	City:	Mölndal
Postal address:	Aminogatan 25	Telephone number:	+46 31 886344
Postcode:	431 53	E-mail address:	sales@kvaser.com

**declare that the DoC is issued under our sole responsibility and belongs to the following product:**

Product: Kvaser Leaf Professional LIN

**Object of the declaration** (identification of apparatus allowing traceability):

Product: Kvaser Leaf Professional LIN

Type: 73-30130-00269-2

**The object of the declaration described above is in conformity with the relevant Union harmonisation legislation:**

DIRECTIVE 2004/108/EC OF THE EUROPEAN PARLIAMENT AND OF THE COUNCIL of 15 December 2004 (EMC-directive)

RoHS recast Directive 2011/65/EU (Art. 4.1)

**The following harmonised standards and technical specifications have been applied**

(title, date of standard/specification):

EN 50581 (2012)

**Signed for and on behalf of:**

Mölndal

2019-12-05

Place of issue

Date of issue

  
Claes Haglund, Supply Chain and Quality Director



## EU Declaration of Conformity (DoC)

## We

Company Name:	Kvaser AB	City:	Mölndal
Postal address:	Aminogatan 25	Telephone number:	+46 31 886344
Postcode:	431 53	E-mail address:	sales@kvaser.com

declare that the DoC is issued under our sole responsibility and belongs to the following product:

Product: Kvaser Leaf Light HS OBDII

**Object of the declaration** (identification of apparatus allowing traceability):

Product: Kvaser Leaf Light HS OBDII

Type: 73-30130-00402-3

**The object of the declaration described above is in conformity with the relevant Union harmonisation legislation:**

DIRECTIVE 2004/108/EC OF THE EUROPEAN PARLIAMENT AND OF THE COUNCIL of 15 December 2004 (EMC-directive)

RoHS recast Directive 2011/65/EU (Art. 4.1)

**The following harmonised standards and technical specifications have been applied**

(title, date of standard/specification):

EN 50581 (2012)

Signed for and on behalf of:

Mölndal

2019-12-05

Place of issue

Date of issue

  
Claes Haglund, Supply Chain and Quality Director



## EU Declaration of Conformity (DoC)

## We

Company Name:	Kvaser AB	City:	Mölndal
Postal address:	Aminogatan 25	Telephone number:	+46 31 886344
Postcode:	431 53	E-mail address:	sales@kvaser.com

declare that the DoC is issued under our sole responsibility and belongs to the following product:

Product: Kvaser Leaf Professional HS OBDII

**Object of the declaration** (identification of apparatus allowing traceability):

Product: Kvaser Leaf Professional HS OBDII

Type: 73-30130-00404-7

**The object of the declaration described above is in conformity with the relevant Union harmonisation legislation:**

DIRECTIVE 2004/108/EC OF THE EUROPEAN PARLIAMENT AND OF THE COUNCIL of 15 December 2004 (EMC-directive)

RoHS recast Directive 2011/65/EU (Art. 4.1)

**The following harmonised standards and technical specifications have been applied**

(title, date of standard/specification):

EN 50581 (2012)

Signed for and on behalf of:

Mölndal

2019-12-05

Place of issue

Date of issue

  
Claes Haglund, Supply Chain and Quality Director



## EU Declaration of Conformity (DoC)

## We

Company Name:	Kvaser AB	City:	Möln dal
Postal address:	Aminogatan 25	Telephone number:	+46 31 886344
Postcode:	431 53	E-mail address:	sales@kvaser.com

**declare that the DoC is issued under our sole responsibility and belongs to the following product:**

Product: Kvaser Leaf Light GI HS

**Object of the declaration** (identification of apparatus allowing traceability):

Product: Kvaser Leaf Light GI HS

Type: 73-30130-00411-5

**The object of the declaration described above is in conformity with the relevant Union harmonisation legislation:**

DIRECTIVE 2004/108/EC OF THE EUROPEAN PARLIAMENT AND OF THE COUNCIL of 15 December 2004 (EMC-directive)

RoHS recast Directive 2011/65/EU (Art. 4.1)

**The following harmonised standards and technical specifications have been applied** (title, date of standard/specification):

EN 50581 (2012)

**Signed for and on behalf of:**

Möln dal

2019-12-05

Place of issue

Date of issue

  
Claes Haglund, Supply Chain and Quality Director



## EU Declaration of Conformity (DoC)

## We

Company Name:	Kvaser AB	City:	Mölnadal
Postal address:	Aminogatan 25	Telephone number:	+46 31 886344
Postcode:	431 53	E-mail address:	sales@kvaser.com

**declare that the DoC is issued under our sole responsibility and belongs to the following product:**

Product: Kvaser Leaf Light Rugged HS

**Object of the declaration** (identification of apparatus allowing traceability):

Product: Kvaser Leaf Light Rugged HS

Type: 73-30130-00427-6

**The object of the declaration described above is in conformity with the relevant Union harmonisation legislation:**

DIRECTIVE 2004/108/EC OF THE EUROPEAN PARLIAMENT AND OF THE COUNCIL of 15 December 2004 (EMC-directive)

RoHS recast Directive 2011/65/EU (Art. 4.1)

**The following harmonised standards and technical specifications have been applied**

(title, date of standard/specification):

EN 50581 (2012)

**Signed for and on behalf of:**

Mölnadal

2019-12-05

Place of issue

Date of issue

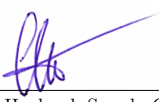
  
Claes Haglund, Supply Chain and Quality Director



## EU Declaration of Conformity (DoC)

## We

Company Name:	Kvaser AB	City:	Möln dal
Postal address:	Aminogatan 25	Telephone number:	+46 31 886344
Postcode:	431 53	E-mail address:	sales@kvaser.com

declare that the DoC is issued under our sole responsibility and belongs to the following product:

Product: Kvaser Leaf SemiPro Rugged

**Object of the declaration** (identification of apparatus allowing traceability):

Product: Kvaser Leaf SemiPro Rugged

Type: 73-30130-00506-8

**The object of the declaration described above is in conformity with the relevant Union harmonisation legislation:**

DIRECTIVE 2004/108/EC OF THE EUROPEAN PARLIAMENT AND OF THE COUNCIL of 15 December 2004 (EMC-directive)

RoHS recast Directive 2011/65/EU (Art. 4.1)

**The following harmonised standards and technical specifications have been applied**

(title, date of standard/specification):

EN 50581 (2012)

Signed for and on behalf of:

Möln dal

2019-12-05

Place of issue

Date of issue

  
Claes Haglund, Supply Chain and Quality Director



## EU Declaration of Conformity (DoC)

## We

Company Name:	Kvaser AB	City:	Mölndal
Postal address:	Aminogatan 25	Telephone number:	+46 31 886344
Postcode:	431 53	E-mail address:	sales@kvaser.com

declare that the DoC is issued under our sole responsibility and belongs to the following product:

Product: Kvaser Leaf Professional Rugged HS

**Object of the declaration** (identification of apparatus allowing traceability):

Product: Kvaser Leaf Professional Rugged HS

Type: 73-30130-00509-9

**The object of the declaration described above is in conformity with the relevant Union harmonisation legislation:**

DIRECTIVE 2004/108/EC OF THE EUROPEAN PARLIAMENT AND OF THE COUNCIL of 15 December 2004 (EMC-directive)

RoHS recast Directive 2011/65/EU (Art. 4.1)

**The following harmonised standards and technical specifications have been applied**

(title, date of standard/specification):

EN 50581 (2012)

Signed for and on behalf of:

Mölndal

2019-12-05

Place of issue

Date of issue

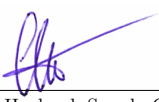
  
Claes Haglund, Supply Chain and Quality Director





## EU Declaration of Conformity (DoC)

## We

Company Name:	Kvaser AB	City:	Möln dal
Postal address:	Aminogatan 25	Telephone number:	+46 31 886344
Postcode:	431 53	E-mail address:	sales@kvaser.com

declare that the DoC is issued under our sole responsibility and belongs to the following product:

Product: Kvaser Leaf Light J1939-13

**Object of the declaration** (identification of apparatus allowing traceability):

Product: Kvaser Leaf Light J1939-13

Type: 73-30130-00642-3

**The object of the declaration described above is in conformity with the relevant Union harmonisation legislation:**

DIRECTIVE 2004/108/EC OF THE EUROPEAN PARLIAMENT AND OF THE COUNCIL of 15 December 2004 (EMC-directive)

RoHS recast Directive 2011/65/EU (Art. 4.1)

**The following harmonised standards and technical specifications have been applied**

(title, date of standard/specification):

EN 50581 (2012)

Signed for and on behalf of:

Möln dal

2019-12-05

Place of issue

Date of issue

  
Claes Haglund, Supply Chain and Quality Director

### 13.3 FCC Regulatory Compliance



#### Federal Communications Commission (FCC) Compliance Information Statement

**IDENTIFICATION OBJECT:**

Product: Kvaser Leaf Light HS

Type: 73-30130-00241-8

**APPLICABLE COMPLIANCE STATEMENTS:**

CFR Title 47 Part 15 §15.107, §15.109

This device complies with part 15 of the FCC Rules.

Operation is subject to the following two conditions:

- (1) This device may not cause harmful interference, and
- (2) this device must accept any interference received, including interference that may cause undesired operation.

**RESPONSIBLE PARTY (IN USA) NAME:**

Kvaser Inc.

23881 Via Fabricante, Suite 503

Mission Viejo, CA 92691

Internet contact: [support@kvaser.com](mailto:support@kvaser.com)



Federal Communications Commission (FCC) Compliance Information Statement

**IDENTIFICATION OBJECT:**

Product: Kvaser Leaf Semipro HS

Type: 73-30130-00242-5

**APPLICABLE COMPLIANCE STATEMENTS:**

CFR Title 47 Part 15 §15.107, §15.109

This device complies with part 15 of the FCC Rules.

Operation is subject to the following two conditions:

- (1) This device may not cause harmful interference, and
- (2) this device must accept any interference received, including interference that may cause undesired operation.

**RESPONSIBLE PARTY (IN USA) NAME:**

Kvaser Inc.

23881 Via Fabricante, Suite 503

Mission Viejo, CA 92691

Internet contact: [support@kvaser.com](mailto:support@kvaser.com)



Federal Communications Commission (FCC) Compliance Information Statement

**IDENTIFICATION OBJECT:**

Product: Kvaser Leaf Professional HS

Type: 73-30130-00243-2

**APPLICABLE COMPLIANCE STATEMENTS:**

CFR Title 47 Part 15 §15.107, §15.109

This device complies with part 15 of the FCC Rules.

Operation is subject to the following two conditions:

- (1) This device may not cause harmful interference, and
- (2) this device must accept any interference received, including interference that may cause undesired operation.

**RESPONSIBLE PARTY (IN USA) NAME:**

Kvaser Inc.

23881 Via Fabricante, Suite 503

Mission Viejo, CA 92691

Internet contact: [support@kvaser.com](mailto:support@kvaser.com)



Federal Communications Commission (FCC) Compliance Information Statement

**IDENTIFICATION OBJECT:**

Product: Kvaser Leaf Semipro LS

Type: 73-30130-00260-9

**APPLICABLE COMPLIANCE STATEMENTS:**

CFR Title 47 Part 15 §15.107, §15.109

This device complies with part 15 of the FCC Rules.

Operation is subject to the following two conditions:

- (1) This device may not cause harmful interference, and
- (2) this device must accept any interference received, including interference that may cause undesired operation.

**RESPONSIBLE PARTY (IN USA) NAME:**

Kvaser Inc.

23881 Via Fabricante, Suite 503

Mission Viejo, CA 92691

Internet contact: [support@kvaser.com](mailto:support@kvaser.com)



Federal Communications Commission (FCC) Compliance Information Statement

**IDENTIFICATION OBJECT:**

Product: Kvaser Leaf Professional LS

Type: 73-30130-00261-6

**APPLICABLE COMPLIANCE STATEMENTS:**

CFR Title 47 Part 15 §15.107, §15.109

This device complies with part 15 of the FCC Rules.

Operation is subject to the following two conditions:

- (1) This device may not cause harmful interference, and
- (2) this device must accept any interference received, including interference that may cause undesired operation.

**RESPONSIBLE PARTY (IN USA) NAME:**

Kvaser Inc.

23881 Via Fabricante, Suite 503

Mission Viejo, CA 92691

Internet contact: [support@kvaser.com](mailto:support@kvaser.com)



Federal Communications Commission (FCC) Compliance Information Statement

**IDENTIFICATION OBJECT:**

Product: Kvaser Leaf Semipro SWC

Type: 73-30130-00263-0

**APPLICABLE COMPLIANCE STATEMENTS:**

CFR Title 47 Part 15 §15.107, §15.109

This device complies with part 15 of the FCC Rules.

Operation is subject to the following two conditions:

- (1) This device may not cause harmful interference, and
- (2) this device must accept any interference received, including interference that may cause undesired operation.

**RESPONSIBLE PARTY (IN USA) NAME:**

Kvaser Inc.

23881 Via Fabricante, Suite 503

Mission Viejo, CA 92691

Internet contact: [support@kvaser.com](mailto:support@kvaser.com)



Federal Communications Commission (FCC) Compliance Information Statement

**IDENTIFICATION OBJECT:**

Product: Kvaser Leaf Professional SWC

Type: 73-30130-00264-7

**APPLICABLE COMPLIANCE STATEMENTS:**

CFR Title 47 Part 15 §15.107, §15.109

This device complies with part 15 of the FCC Rules.

Operation is subject to the following two conditions:

- (1) This device may not cause harmful interference, and
- (2) this device must accept any interference received, including interference that may cause undesired operation.

**RESPONSIBLE PARTY (IN USA) NAME:**

Kvaser Inc.

23881 Via Fabricante, Suite 503

Mission Viejo, CA 92691

Internet contact: [support@kvaser.com](mailto:support@kvaser.com)





Federal Communications Commission (FCC) Compliance Information Statement

**IDENTIFICATION OBJECT:**

Product: Kvaser Leaf Professional LIN

Type: 73-30130-00269-2

**APPLICABLE COMPLIANCE STATEMENTS:**

CFR Title 47 Part 15 §15.107, §15.109

This device complies with part 15 of the FCC Rules.

Operation is subject to the following two conditions:

- (1) This device may not cause harmful interference, and
- (2) this device must accept any interference received, including interference that may cause undesired operation.

**RESPONSIBLE PARTY (IN USA) NAME:**

Kvaser Inc.

23881 Via Fabricante, Suite 503

Mission Viejo, CA 92691

Internet contact: [support@kvaser.com](mailto:support@kvaser.com)



Federal Communications Commission (FCC) Compliance Information Statement

**IDENTIFICATION OBJECT:**

Product: Kvaser Leaf Light HS OBDII

Type: 73-30130-00402-3

**APPLICABLE COMPLIANCE STATEMENTS:**

CFR Title 47 Part 15 §15.107, §15.109

This device complies with part 15 of the FCC Rules.

Operation is subject to the following two conditions:

- (1) This device may not cause harmful interference, and
- (2) this device must accept any interference received, including interference that may cause undesired operation.

**RESPONSIBLE PARTY (IN USA) NAME:**

Kvaser Inc.

23881 Via Fabricante, Suite 503

Mission Viejo, CA 92691

Internet contact: [support@kvaser.com](mailto:support@kvaser.com)



Federal Communications Commission (FCC) Compliance Information Statement

**IDENTIFICATION OBJECT:**

Product: Kvaser Leaf Professional HS OBDII

Type: 73-30130-00404-7

**APPLICABLE COMPLIANCE STATEMENTS:**

CFR Title 47 Part 15 §15.107, §15.109

This device complies with part 15 of the FCC Rules.

Operation is subject to the following two conditions:

- (1) This device may not cause harmful interference, and
- (2) this device must accept any interference received, including interference that may cause undesired operation.

**RESPONSIBLE PARTY (IN USA) NAME:**

Kvaser Inc.

23881 Via Fabricante, Suite 503

Mission Viejo, CA 92691

Internet contact: [support@kvaser.com](mailto:support@kvaser.com)



Federal Communications Commission (FCC) Compliance Information Statement

**IDENTIFICATION OBJECT:**

Product: Kvaser Leaf Light GI HS

Type: 73-30130-00411-5

**APPLICABLE COMPLIANCE STATEMENTS:**

CFR Title 47 Part 15 §15.107, §15.109

This device complies with part 15 of the FCC Rules.

Operation is subject to the following two conditions:

- (1) This device may not cause harmful interference, and
- (2) this device must accept any interference received, including interference that may cause undesired operation.

**RESPONSIBLE PARTY (IN USA) NAME:**

Kvaser Inc.

23881 Via Fabricante, Suite 503

Mission Viejo, CA 92691

Internet contact: [support@kvaser.com](mailto:support@kvaser.com)



Federal Communications Commission (FCC) Compliance Information Statement

**IDENTIFICATION OBJECT:**

Product: Kvaser Leaf Light Rugged HS

Type: 73-30130-00427-6

**APPLICABLE COMPLIANCE STATEMENTS:**

CFR Title 47 Part 15 §15.107, §15.109

This device complies with part 15 of the FCC Rules.

Operation is subject to the following two conditions:

- (1) This device may not cause harmful interference, and
- (2) this device must accept any interference received, including interference that may cause undesired operation.

**RESPONSIBLE PARTY (IN USA) NAME:**

Kvaser Inc.

23881 Via Fabricante, Suite 503

Mission Viejo, CA 92691

Internet contact: [support@kvaser.com](mailto:support@kvaser.com)



Federal Communications Commission (FCC) Compliance Information Statement

**IDENTIFICATION OBJECT:**

Product: Kvaser Leaf SemiPro Rugged

Type: 73-30130-00506-8

**APPLICABLE COMPLIANCE STATEMENTS:**

CFR Title 47 Part 15 §15.107, §15.109

This device complies with part 15 of the FCC Rules.

Operation is subject to the following two conditions:

- (1) This device may not cause harmful interference, and
- (2) this device must accept any interference received, including interference that may cause undesired operation.

**RESPONSIBLE PARTY (IN USA) NAME:**

Kvaser Inc.

23881 Via Fabricante, Suite 503

Mission Viejo, CA 92691

Internet contact: [support@kvaser.com](mailto:support@kvaser.com)



Federal Communications Commission (FCC) Compliance Information Statement

**IDENTIFICATION OBJECT:**

Product: Kvaser Leaf Professional Rugged HS

Type: 73-30130-00509-9

**APPLICABLE COMPLIANCE STATEMENTS:**

CFR Title 47 Part 15 §15.107, §15.109

This device complies with part 15 of the FCC Rules.

Operation is subject to the following two conditions:

- (1) This device may not cause harmful interference, and
- (2) this device must accept any interference received, including interference that may cause undesired operation.

**RESPONSIBLE PARTY (IN USA) NAME:**

Kvaser Inc.

23881 Via Fabricante, Suite 503

Mission Viejo, CA 92691

Internet contact: [support@kvaser.com](mailto:support@kvaser.com)



Federal Communications Commission (FCC) Compliance Information Statement

**IDENTIFICATION OBJECT:**

Product: Kvaser Leaf Light J1939-13

Type: 73-30130-00642-3

**APPLICABLE COMPLIANCE STATEMENTS:**

CFR Title 47 Part 15 §15.107, §15.109

This device complies with part 15 of the FCC Rules.

Operation is subject to the following two conditions:

- (1) This device may not cause harmful interference, and
- (2) this device must accept any interference received, including interference that may cause undesired operation.

**RESPONSIBLE PARTY (IN USA) NAME:**

Kvaser Inc.

23881 Via Fabricante, Suite 503

Mission Viejo, CA 92691

Internet contact: [support@kvaser.com](mailto:support@kvaser.com)



## 13.4 About this manual

This document is Copyright © 2005-2023 Kvaser AB

This document may not be reproduced without our written permission. Infringement will render the user liable to prosecution.

We believe that the information contained herein was accurate in all respects at the time of printing. Kvaser AB cannot, however, assume any responsibility for errors or omissions in this text. Please also note that the information in this document is subject to change without notice and should not be construed as a commitment on the part of Kvaser AB.

## 13.5 Patents, copyrights, and trademarks

All trademarks are the property of their respective owner.

Windows® is a registered trademark of Microsoft Corporation in the United States and other countries. Linux® is the registered trademark of Linus Torvalds in the United States and other countries. MagiSync™ is a trademark of Kvaser AB. DeviceNet™ is a Trademark of Open DeviceNet Vendor Association, Inc. NMEA 2000® is the registered trademark of the National Marine Electronics Association, Inc.

The products described in this document are protected by U.S. patent 5,696,911.

## 14 Document revision history

Version history for document UG\_98035\_leaf:

Revision	Date	Changes
1	2006	Older Versions
2	2006-11-13	Reviewed, new layout
3	2008-05-27	Added Kvaser Leaf Light Rugged. Added more information about bus termination. Other minor editorial changes.
4	2008-12-03	Added several new part numbers in Table 1.
5	2009-02-24	Added SemiPro Rugged and Professional Rugged. Added Light with OBDII connector. Removed table 1 with all part numbers – this information is better obtained from our web site.
6	2011-01-21	Updated dimensions for Kvaser Leaf Light Rugged, updated temperature range for Kvaser Leaf Light HS, updated product images, and removed transceiver types from technical data tables. Other minor editorial changes.
7	2011-09-12	Updated disposal information
8	2012-02-22	Added Kvaser Leaf Light with J1939-13 connector.
9	2012-05-21	Connected pin numbering OBDII connector.
10	2012-06-29	Corrected references to J1939-13 connector.
11	2014-02-26	Updated compliance text, layout changes (reduced number of pages). Changed layout of references, figures.
12	2014-04-15	Renumbered pages, corrected J1939-13 connector table.
13	2015-03-06	Updated the operating voltage range for Kvaser Leaf LIN.
14	2016-10-27	Updated compliance text
15	2019-02-11	Windows Vista or later supported
16	2019-06-17	“Kvaser Device Guide” has replaced “Kvaser Hardware”
16.1	2019-08-01	Url protocol updated
16.2	2020-01-27	Added DoC:s and sdoc:s
16.3	2020-08-19	Updated supported OS
16.4	2021-02-08	Removed Max message rate from table 21
16.5	2023-02-13	Stated in the Technical data table that Kvaser t programming is not supported. Added section about safety instructions