

# Kvaser USBcan Pro 2xHS v2 CB User's Guide



Copyright 2016-2020 Kvaser AB, Mölndal, Sweden  
<https://www.kvaser.com>

Printed Wednesday 9<sup>th</sup> September, 2020

We believe that the information contained herein was accurate in all respects at the time of printing. Kvaser AB cannot, however, assume any responsibility for errors or omissions in this text. Also note that the information in this document is subject to change without notice and should not be construed as a commitment by Kvaser AB.

(This page is intentionally left blank.)

## Contents

<b>1</b>	<b>About this manual</b>	<b>4</b>
<b>2</b>	<b>Welcome to Kvaser USBcan Pro 2xHS v2 CB</b>	<b>5</b>
<b>3</b>	<b>Layout</b>	<b>6</b>
<b>4</b>	<b>Connectors</b>	<b>8</b>
4.1	USB connector . . . . .	8
4.2	CAN connector . . . . .	8
<b>5</b>	<b>LED indicators</b>	<b>10</b>
<b>6</b>	<b>Disposal and Recycling Information</b>	<b>11</b>
<b>7</b>	<b>Legal acknowledgements</b>	<b>12</b>
7.1	Usage warning . . . . .	12
7.2	EU Regulatory Compliance . . . . .	13
7.3	FCC Regulatory Compliance . . . . .	14
7.4	Patents, Copyrights and Trademarks . . . . .	15
<b>8</b>	<b>Document Revision History</b>	<b>16</b>

## 1 About this manual

This document describes a printed circuit board assembly version of the Kvaser USBcan Pro 2xHS v2. This document contains a description of the hardware properties, the device's physical dimensions and instructions for connecting the device to a CAN bus and a USB bus. For further information, please refer to the Kvaser USBcan Pro 2xHS v2 User's Guide.

## 2 Welcome to Kvaser USBcan Pro 2xHS v2 CB

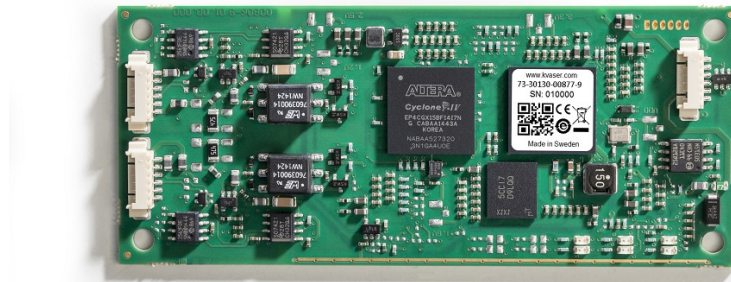

Figure 1: Kvaser USBcan Pro 2xHS v2 CB

This guide applies to Kvaser USBcan Pro 2xHS v2 CB devices listed in Table 1.

Device	Product Number
Kvaser USBcan Pro HS v2 CB	73-30130-00877-9

Table 1: Kvaser USBcan Pro 2xHS v2 CB devices and their EAN numbers.

Throughout this document, we use the name Kvaser USBcan Pro 2xHS v2 CB to refer to the product listed in Table 1.

### 3 Layout

Kvaser USBcan Pro 2xHS v2 CB consists of a printed circuit board (PCB) populated with components.

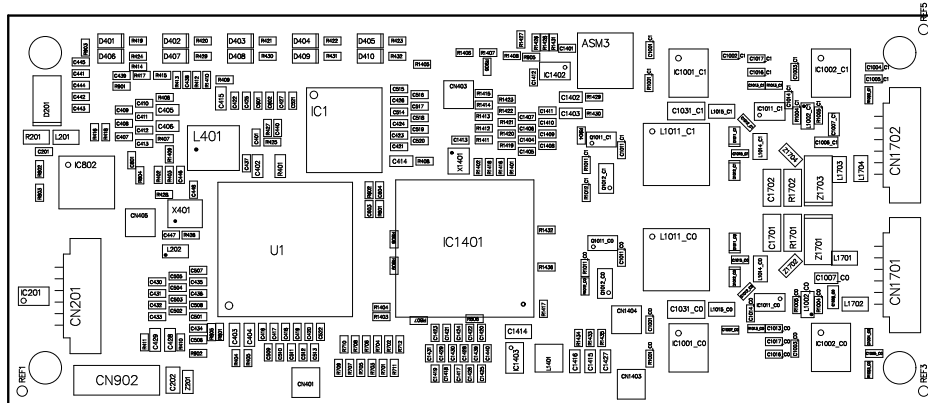

Figure 2: Top view of Kvaser USBcan Pro 2xHS v2 CB

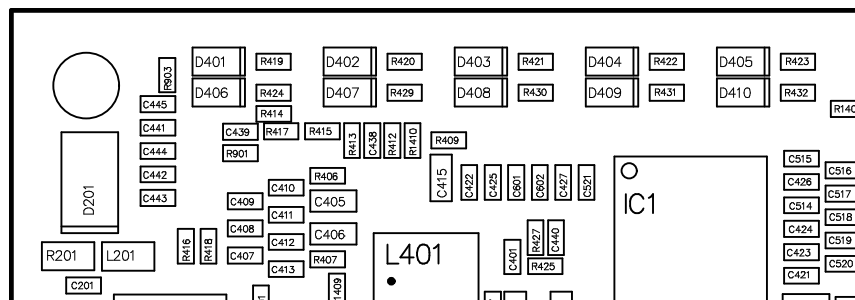

Figure 3: Placement of LEDs (D401–D403 + D406–D408) in top left corner of top side.

The power LEDs are placed on the top left (D401 and D406), with the CAN LEDs placed to the right (D402–D403 and D407–D408), see Figure 3. The USB connector is placed to the left on the top side (CN201) and the CAN connectors to the right on the top side (CN1701) and (CN1702).

The outline in Figure 4 on Page 7 also shows the four mounting holes which have a diameter of 3.5 mm.

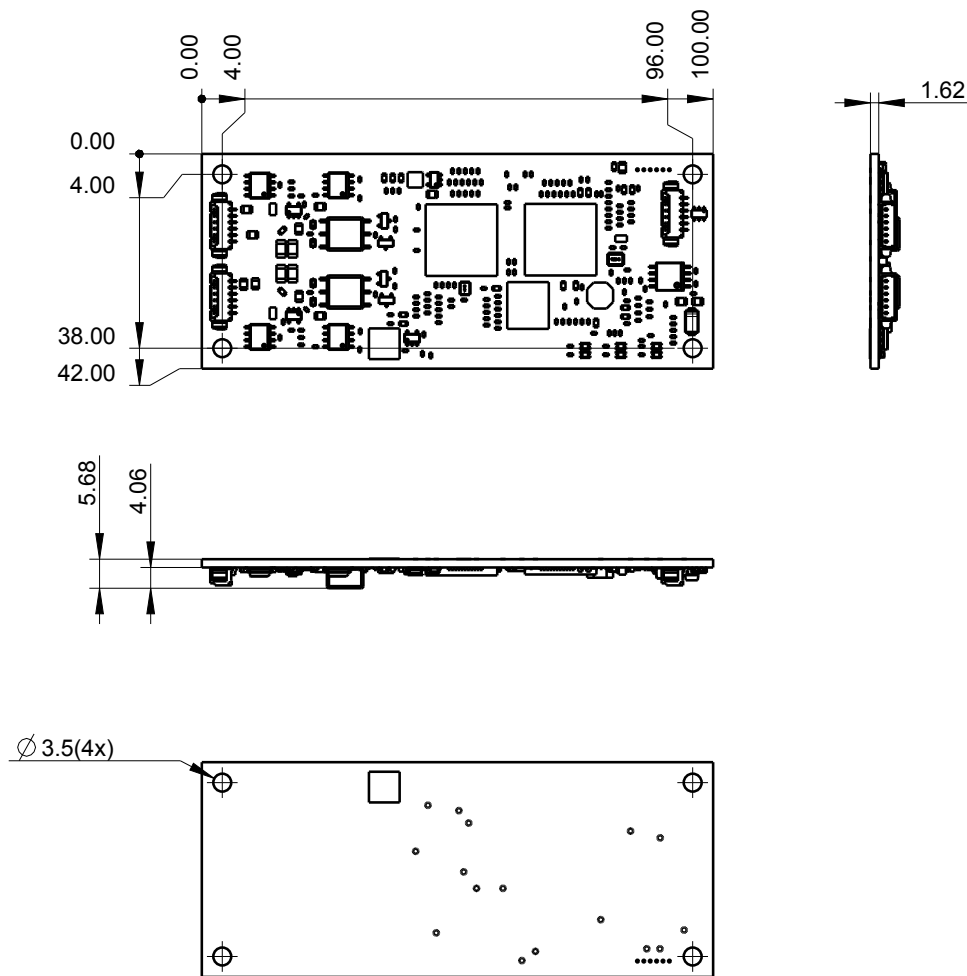

Figure 4: Physical dimensions of Kvaser USBcan Pro 2xHS v2 CB.

## 4 Connectors

### 4.1 USB connector

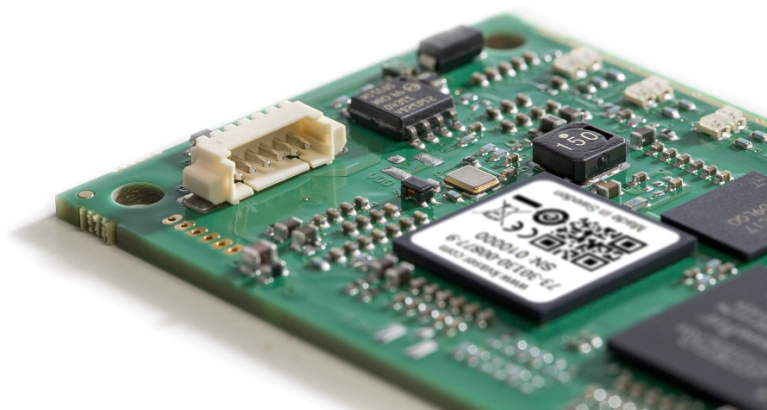

Figure 5: USB connector on Kvaser USBcan Pro 2xHS v2 CB

The Kvaser USBcan Pro 2xHS v2 CB has a 6-way connector (top side) and mate with Molex 51021 PicoBlade™ (housing 51021-0600, with terminal 50079-8000), as seen in Figure 5. Figure 2 on Page 6 and Figure 5 show the placement of the USB connector. Table 2 describe the USB connector pin configuration.

Pin Number	USB (CN201)
1	Shield
2	GND
3	D+
4	D-
5	VBUS
6	Not connected

Table 2: Pin configuration of the USB connector.

### 4.2 CAN connector

CAN is connected using two 6-way connectors (top side) and mate with Molex 51021 PicoBlade™ (housing 51021-0600, with terminal 50079-8000), as seen in Figure 6 on Page 9. Figure 2 on Page 6 show the placement of the CAN connectors. Table 3 on Page 9 describe the CAN connector pin configuration.



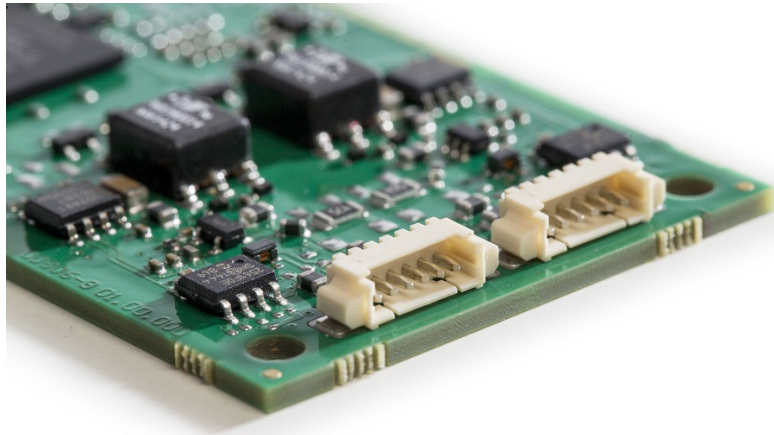

Figure 6: CAN connectors on Kvaser USBcan Pro 2xHS v2 CB

Pin Number	CAN 1 (CN1701)	CAN 2 (CN1702)
1	Ground	Ground
2	Not connected	Not connected
3	CAN_H channel 1	CAN_H channel 2
4	CAN_L channel 1	CAN_L channel 2
5	Not connected	Not connected
6	Shield	Shield

Table 3: Pin configuration of the two CAN connectors.

## 5 LED indicators

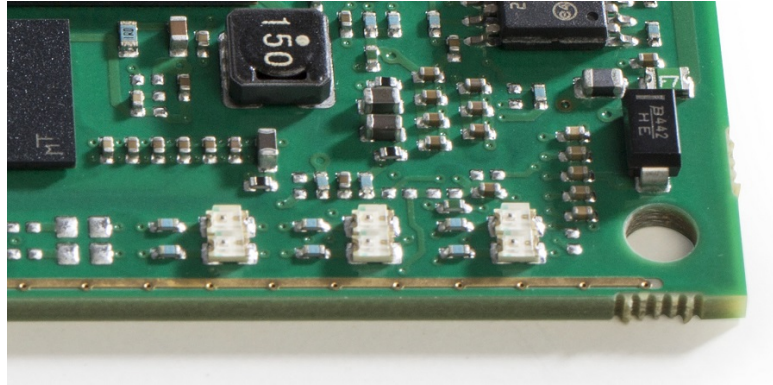

Figure 7: The LEDs on Kvaser USBcan Pro 2xHS v2 CB

Figure 7 show the LEDs on the PCB. For further information about the LED functionality, please refer to the Kvaser USBcan Pro 2xHS v2 User's Guide.

## 6 Disposal and Recycling Information



When this product reaches its end of life, please dispose of it according to your local environmental laws and guidelines.

For information about Kvaser's recycling programs, visit:  
<https://www.kvaser.com/en/kvaser/recycling-policy.html>

## 7 Legal acknowledgements

### 7.1 Usage warning



#### **WARNING FOR ALL USERS**

WARNING! - YOUR USE OF THIS DEVICE MUST BE DONE WITH CAUTION AND A FULL UNDERSTANDING OF THE RISKS!

THIS WARNING IS PRESENTED TO INFORM YOU THAT THE OPERATION OF THIS DEVICE MAY BE DANGEROUS. YOUR ACTIONS CAN INFLUENCE THE BEHAVIOR OF A CAN-BASED DISTRIBUTED EMBEDDED SYSTEM, AND DEPENDING ON THE APPLICATION, THE CONSEQUENCES OF YOUR IMPROPER ACTIONS COULD CAUSE SERIOUS OPERATIONAL MALFUNCTION, LOSS OF INFORMATION, DAMAGE TO EQUIPMENT, AND PHYSICAL INJURY TO YOURSELF AND OTHERS. A POTENTIALLY HAZARDOUS OPERATING CONDITION IS PRESENT WHEN THE FOLLOWING TWO CONDITIONS ARE CONCURRENTLY TRUE: THE PRODUCT IS PHYSICALLY INTERCONNECTED TO A REAL DISTRIBUTED EMBEDDED SYSTEM; AND THE FUNCTIONS AND OPERATIONS OF THE REAL DISTRIBUTED EMBEDDED SYSTEM ARE CONTROLLABLE OR INFLUENCED BY THE USE OF THE CAN NETWORK. A POTENTIALLY HAZARDOUS OPERATING CONDITION MAY RESULT FROM THE ACTIVITY OR NON-ACTIVITY OF SOME DISTRIBUTED EMBEDDED SYSTEM FUNCTIONS AND OPERATIONS, WHICH MAY RESULT IN SERIOUS PHYSICAL HARM OR DEATH OR CAUSE DAMAGE TO EQUIPMENT, DEVICES, OR THE SURROUNDING ENVIRONMENT.

WITH THIS DEVICE, YOU MAY POTENTIALLY:

- CAUSE A CHANGE IN THE OPERATION OF THE SYSTEM, MODULE, DEVICE, CIRCUIT, OR OUTPUT.
- TURN ON OR ACTIVATE A MODULE, DEVICE, CIRCUIT, OUTPUT, OR FUNCTION.
- TURN OFF OR DEACTIVATE A MODULE, DEVICE, CIRCUIT, OUTPUT, OR FUNCTION.
- INHIBIT, TURN OFF, OR DEACTIVATE NORMAL OPERATION.
- MODIFY THE BEHAVIOR OF A DISTRIBUTED PRODUCT.
- ACTIVATE AN UNINTENDED OPERATION.
- PLACE THE SYSTEM, MODULE, DEVICE, CIRCUIT, OR OUTPUT INTO AN UNINTENDED MODE.

ONLY THOSE PERSONS WHO:

(A) ARE PROPERLY TRAINED AND QUALIFIED WITH RESPECT TO THE USE OF THE DEVICE,

(B) UNDERSTAND THE WARNINGS ABOVE, AND

(C) UNDERSTAND HOW THIS DEVICE INTERACTS WITH AND IMPACTS THE FUNCTION AND SAFETY OF OTHER PRODUCTS IN A DISTRIBUTED SYSTEM AND THE APPLICATION FOR WHICH THIS DEVICE WILL BE APPLIED, MAY USE THE DEVICE.

PLEASE NOTE THAT YOU CAN INTEGRATE THIS PRODUCT AS A SUBSYSTEM INTO HIGHER-LEVEL SYSTEMS. IN CASE YOU DO SO, KVASER AB HEREBY DECLARES THAT KVASER AB'S WARRANTY SHALL BE LIMITED TO THE CORRECTION OF DEFECTS, AND KVASER AB HEREBY EXPRESSLY DISCLAIMS ANY LIABILITY OVER AND ABOVE THE REFUNDING OF THE PRICE PAID FOR THIS DEVICE, SINCE KVASER AB DOES NOT HAVE ANY INFLUENCE ON THE IMPLEMENTATIONS OF THE HIGHER-LEVEL SYSTEM, WHICH MAY BE DEFECTIVE.

## 7.2 EU Regulatory Compliance



### EU Declaration of Conformity (DoC)

**We**

Company Name:	Kvaser AB	City:	Mölnådal
Postal address:	Aminogatan 25	Telephone number:	+46 31 886344
Postcode:	431 53	E-mail address:	sales@kvaser.com

**declare that the DoC is issued under our sole responsibility and belongs to the following product:**

Product: Kvaser USBcan Pro 2xHS v2 CB

**Object of the declaration** (identification of apparatus allowing traceability):

Product: Kvaser USBcan Pro 2xHS v2 CB

Type: 73-30130-00877-9

**The object of the declaration described above is in conformity with the relevant Union harmonisation legislation:**

Electromagnetic Compatibility (EMC) Directive 2014/30/EU (Art. 6)

RoHS recast Directive 2011/65/EU (Art. 4.1)

**The following harmonised standards and technical specifications have been applied**

(title, date of standard/specification):

EN 55024 (2010) EN 55032 (2012)

EN 61000-6-3 (2007 + A1:2011) EN 50581 (2012)

**Signed for and on behalf of:**

Mölnådal	2019-12-05	
Place of issue	Date of issue	Claes Haglund, Supply Chain and Quality director

## 7.3 FCC Regulatory Compliance



### Federal Communications Commission (FCC) Compliance Information Statement

#### **IDENTIFICATION OBJECT:**

Product: Kvaser USBcan Pro 2xHS v2 CB

Type: 73-30130-00877-9

#### **APPLICABLE COMPLIANCE STATEMENTS:**

CFR Title 47 Part 15 §15.107, §15.109

This device complies with part 15 of the FCC Rules.

Operation is subject to the following two conditions:

- (1) This device may not cause harmful interference, and
- (2) this device must accept any interference received, including interference that may cause undesired operation.

#### **RESPONSIBLE PARTY (IN USA) NAME:**

Kvaser Inc.

23881 Via Fabricante, Suite 503

Mission Viejo, CA 92691

Internet contact: [support@kvaser.com](mailto:support@kvaser.com)

## **7.4 Patents, Copyrights and Trademarks**

All trademarks are the property of their respective owner. Windows is a registered trademark of Microsoft Corporation in the United States and other countries.

Adobe, the Adobe logo, and Reader are either registered trademarks or trademarks of Adobe Systems Incorporated in the United States and/or other countries.

MagiSync is a trademark of Kvaser AB.

DeviceNet is a trademark of Open DeviceNet Vendor Association, Inc.

NMEA 2000 is the registered trademark of the National Marine Electronics Association, Inc.

For information about Kvaser related CAN patents, see [www.kvaser.com/patent](http://www.kvaser.com/patent).

The products described in this document are protected by U.S. patent 5,696,911.

## 8 Document Revision History

Version history for document UG\_98184\_usbcan\_pro\_2hs\_v2\_cb:

Revision	Date	Changes
1	2016-02-04	First version.
1.1	2017-01-09	Updated compliance text, added link to patents
2.0	2017-08-25	Updated EU Declaration of Conformity
3.0	2018-10-15	Updated EU Regulatory Compliance
3.2	2019-08-09	Url protocol updated
3.3	2020-01-27	Added sdoc